

REV 更改号	DATE 日期	REVISION DETAILS 更改内容	APPD 审核并批准
A	Jul.01,2019	Drawing Update	

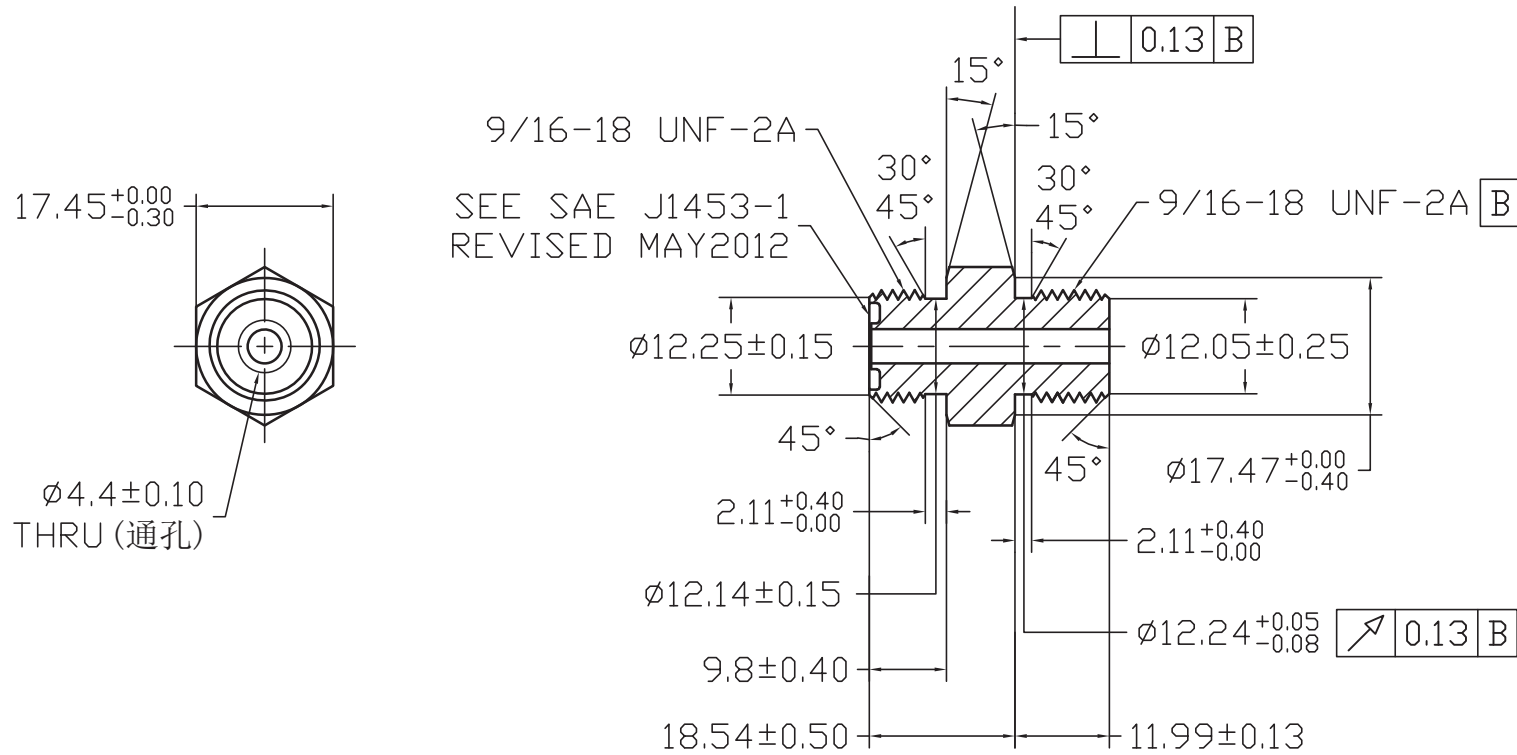

UNLESS SPECIFIED
ALL DIMENSIONS IN mm,
MACHINED SURFACES Ra=3.2um,
ANGLE TOLERANCES ±5°,
Other tolerance except angles,
in accordance with
GB/T1804-2000(ISO2768-1)-m
and GB/T1184-1996(ISO2768-2)-m

其它事项,
图示尺寸单位为mm,
未注机加工表面粗糙度 Ra=3.2um,
未注角度公差 ±5° ,
其它未注公差 (除角度外) 均按:
GB/T1804-2000(ISO2768-1)-m 和
GB/T1184-1996(ISO2768-2)-m

Zhejiang Gaocheng Autoparts Co.,Ltd			
PART No 零件名	6400-4FS-6		
SCALE:	APPD: 批准	DRN: 制图	Pan 2019.07.01
NTS	DATE: 日期	CHK: 审核	Pan 2019.07.01

MATERIAL	Chinese steel 45
FINISH	Remove all sharp edges, burrs, slivers and swarf, break all edges 0.127-0.254mm. ZINC PLATING WITH 8um MICRONS MINIMUM PLATING THICKNESS AND TRIVALENT CHROMATE PASSIVATION AND WITHSTAND 96 HRS TO WHITE / 144 HS TO RED RUST IN SALT SPRAY TEST. 镀锌, 三价铬钝化, 银白色, 盐雾试验96小时无白斑, 144小时无红锈, 镀锌层厚度大于8um.